

IGNITER BM4 / BR4 – Ignites just about anything.

The new IGNITER ignition blower from Leister has been specially developed for installation into pellet and wood chip boilers. The IGNITER BR4 with 3.4 kW has what it takes. The interface was selected so that the ignition blowers can easily be installed into any heating boiler.

Hot-air blower

IGNITER

1		<p>Easy: Connector plug located directly on the device means easy removal and installation and fewer device configurations.</p>
2		<p>Clever: New assembly support for positioning in the furnace.</p>
3		<p>Linked: Connection adapter for air hose located directly on the device with inner 1" thread (no extra accessories needed).</p>
4		<p>Additional: Pipe joint adapter with M14 thread for easy adaptation of the heat conduction lines and extensions (available only for IGNITER BM4).</p>
5		<p>Protected: Heating element protection with phototransistor and device protection via temperature protection circuit.</p>



reddot design award
winner 2013













Clean ignition process due to optimum heat level.

Accessories IGNITER

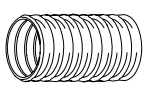
Technical Data	IGNITER BM4							BM4 with M14 screw adapter	BR4	
	Voltage	V	120	120	230	230	230	230	230	230
Frequency	Hz	60	60	50	50	50	50	50	50	
Power rating	W	1100	1550	600	1100	1600	1100	3400		
Min. air volume	l/min 20°C	230	230	80	230	230	230	360		
Air pressure	kPa	2.48	2.48	0.3	2.48	2.48	2.48	4.00		
Max temperature	°C	600	600	500	600	600	600	650		
Noise emission level	dB (A)	68	68	58	68	68	68	68		
Aperture	mm Ø	90								
Weight	kg	1.0 (without power supply cord)								1.2
Length	mm	283								294
Conformity mark		CE c UL us								CE
Safety standard		Ⓢ								
Certification		CCA								
Protection class II		□								
Article no.		141.882	141.881	139.232	140.711	139.231	144.012	146.296		

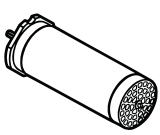
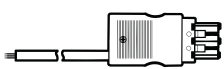
We reserve the right to make technical changes.

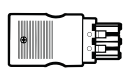
Plug for cable connection and cable are not included.

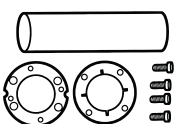
	142.414	Accessory screw adapter for M14 extensions
	153.245	Stainless steel filter kit (ø 38 mm), push-fit on air intake
	107.286	Air hose ø 38 mm / ø 1.5 in
	107.287	Hose bracket
	142.717	Heating element 230V ~ 1550W
	150.871	Heating element 230V ~ 1050W
	150.872	Heating element 230V ~ 550W
	142.718	Heating element 120V ~ 1500W
	150.873	Heating element 120V ~ 1050W
	145.606	Heating element (BR4) 230V ~ 3300W
	142.967	Power supply cord (rubber) with WAGO plug 3 x 1 mm² x 3 m
	143.131	Power supply cord (silicone) with WAGO plug 3 x 1 mm² x 3 m
	142.976	Plug with strain relief, kit (WAGO 770) cable ø 4.5 – 8 mm
	148.429 (BR4)	Plug with strain relief, kit (WAGO 770) cable ø 8 – 11.5 mm
	142.359	Accessory adapter to TRIAC S Economy heating pipe

Installation dimensions in mm

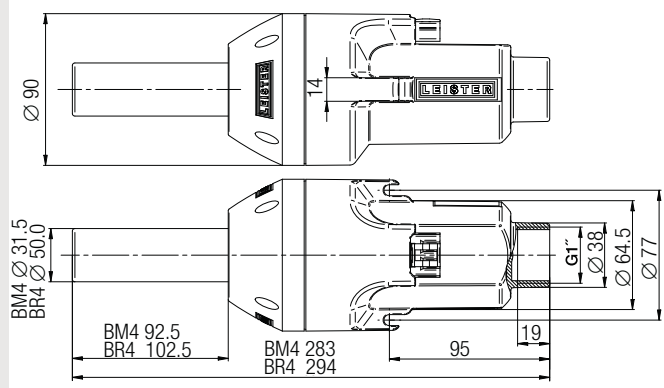

Installation arrangement